

B20E

Low Ground Pressure

6x6

Articulated Dump Trucks

Tier 4 final/Stage 5 Certified



- Gross Power: 170 kW (228 hp)
- Heaped Capacity: 11 m³ (14.5 yd³)
- Rated Payload: 18,000 kg (39,683 lbs)
- Operating Weight: 34,493 kg (76,044 lbs)

BELL

B20E Low Ground Pressure Articulated Dump Truck



ENGINE

Manufacturer
Mercedes Benz (MTU)

Model
OM934LA / 4R 1000

Configuration
Inline 4, turbocharged and intercooled

Gross Power
170 kW (228 hp) @ 2,200 rpm

Net Power
161 kW (216 hp) @ 2,200 rpm

Gross Torque
900 Nm (664 lbft) @ 1,200 - 1,600 rpm

Displacement
5.1 liters (311 cu.in)

Auxiliary Brake
Jacobs Engine Brake®

Fuel Tank Capacity
195 liters (52 US gal)

AdBlue® Tank Capacity
31 liters (8.2 US gal)

Certification
OM934LA meets EPA Tier 4 final/ Stage 5 emissions regulations

TRANSMISSION

Manufacturer
Allison

Model
3200P ORS

Configuration
Fully automatic planetary transmission

Layout
Engine mounted

Gear Layout
Constant meshing planetary gears, clutch operated

Gears
6 Forward, 1 Reverse

Clutch Type
Hydraulically operated multi-disc

Control Type
Electronic

Torque Control
Hydrodynamic with lock-up in all gears

TRANSFER CASE

Manufacturer
Kessler

Series
W1400

Layout
Remote mounted

Gear Layout
Three in-line helical gears

Output Differential
Interaxle 33/67 proportional differential. Automatic inter-axle differential lock

AXLES

Manufacturer
Bell

Model
15T

Differential
High input limited slip differential with spiral bevel gears

Final Drive
Outboard heavy duty planetary on all axles

BRAKING SYSTEM

Service Brake
Dual circuit, full hydraulic actuation wet disc brakes on front and middle axles

Maximum brake force:
173 kN (38,892 lbf)

Park & Emergency
Spring applied, air released driveline mounted disc

Maximum brake force:
193 kN (43,388 lbf)

Auxiliary Brake
Automatic Jacobs Engine Brake®

Total Retardation Power
Continuous: 178 kW (239 hp)
Maximum: 584 kW (783 hp)

WHEELS

STANDARD: Type
Flotation

Tire
800/45 R 30.5

OPTION: Type
Radial Earthmover

Tire
20.5 R 25

FRONT SUSPENSION

Semi-independent, leading A-frame supported by hydro-pneumatic suspension struts

REAR SUSPENSION

Pivoting walking beams with laminated rubber suspension blocks

HYDRAULIC SYSTEM

Full load sensing system serving the prioritized steering, body tipping and brake functions. A ground-driven, load sensing emergency steering pump is integrated into the main system.

Pump Type
Variable displacement load sensing piston

Flow
155 l/min (41 gal/min)

Pressure
27 MPa (3,916 psi)

Filter
5 microns

STEERING SYSTEM

Double acting cylinders, with ground-driven emergency steering pump

Lock to lock turns
4.32

Steering Angle
45°

DUMPING SYSTEM

Two double-acting, single stage, dump cylinders

Raise Time
10 s

Lowering Time
5.5 s

Tipping Angle
70° standard, or any lower angle programmable

PNEUMATIC SYSTEM

Air drier with heater and integral unloader valve, serving park brake and auxiliary functions

System Pressure
810 kPa (117 psi)

ELECTRICAL SYSTEM

Voltage
24 V

Battery Type
Two AGM (Absorption Glass Mat) type

Battery Capacity
2 X 75 Ah

Alternator Rating
28V 80A

VEHICLE SPEEDS

	km/h	mph
1st	6	4
2nd	15	9
3rd	19	12
4th	27	17
5th	36	22
6th	47	29
R	6	4

CAB

ROPS/FOPS certified 71 dBA internal sound level measured according to ISO 6396

Load Capacity & Ground Pressure

OPERATING WEIGHTS		GROUND PRESSURE		LOAD CAPACITY		OPTION WEIGHTS	
UNLADEN	kg (lb)	LADEN (3" sinkage)		BODY	m³ (yd³)	kg (lb)	
Front	8,740 (19,268)	800/45 R 30.5	kPa (Psi)	Struck Capacity	9 (11)	Bin liner	778 (1,715)
Middle	4,016 (8,854)	Front	72 (10)	SAE 2:1 Capacity	11 (14.5)	Tailgate	633 (1,396)
Rear	3,737 (8,239)	Middle	95 (14)	SAE 1:1 Capacity	13.5 (17.5)	Extra wheelset	
Total	16,493 (36,361)	Rear	95 (14)	SAE 2:1 Capacity		800/45 R 30.5	338 (745)
		LADEN (No sinkage)		with Tailgate	11.5 (15)	Extra wheelset	
Front	10,540 (23,237)	20.5 R 25	kPa (Psi)			20.5 R 25	355 (783)
Middle	12,006 (26,469)	Front	215 (31)	Rated Payload	18,000 kg		
Rear	11,947 (26,338)	Middle	309 (45)		(39,683 lbs)		
Total	34,493 (76,044)	Rear	309 (45)				

Dimensions

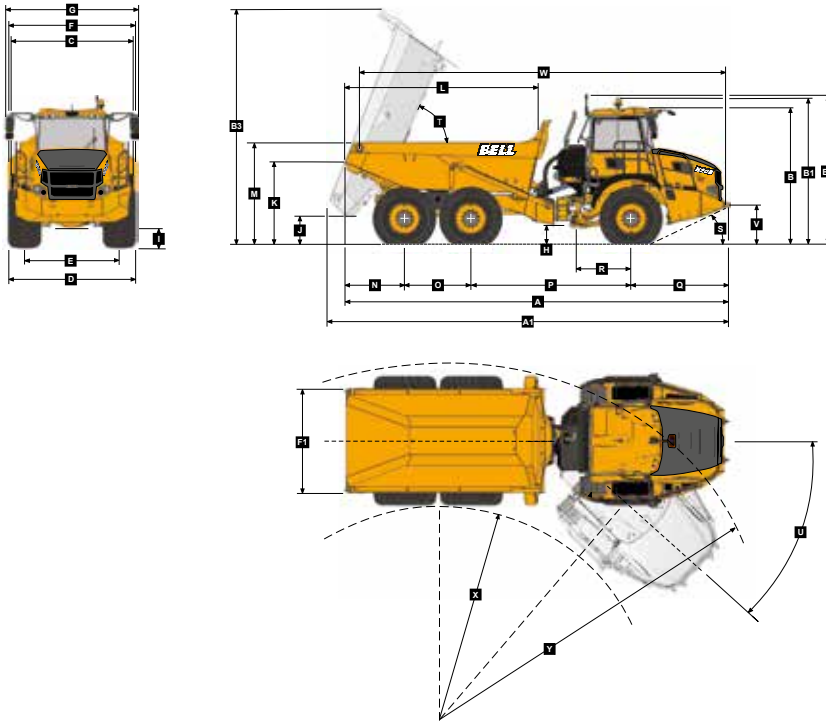

Machine Dimensions

A	Length - Transport Position	9,271 mm (30ft. 5in)
A1	Length - Bin Fully Tipped	9,560 mm (31ft. 4in)
B	Height - Transport Position	3,385 mm (11ft. 1in)
B1	Height - Rotating Beacon	3,619 mm (11ft. 10in)
B2	Height - Load Light	3,702 mm (12ft. 2in)
B3	Bin Height - Fully Tipped	5,742 mm (18ft. 10in)
C	Width over Mudguards	2,984 mm (9ft. 9in)
D	Width over Tires - 800/45-30.5	3,102 mm (10ft. 2in)
D1	Width over Tires - 20.5R25	2,931 mm (9ft.7in)
E	Tire Track Width - 800/45-30.5	2,312 mm (7ft. 7in)
E1	Tire Track Width - 20.5R25	2,399 mm (7ft. 10in)
F	Width over Bin	2,540 mm (8ft. 4 in)
F1	Width over Tailgate	2,838 mm (9ft. 4 in)
G	Width over Mirrors - Operating Position	3,260 mm (10ft. 8in.)
H	Ground Clearance - Artic	498 mm (18.8 6in.)
I	Ground Clearance - Front Axle	458 mm (17.4 8in.)
J	Ground Clearance - Bin Fully Tipped	678 mm (26.3 8in.)
K	Bin Lip Height - Transport Position	2,067mm (6ft. 9in.)
L	Bin Length	4,709 mm (15ft. 5 in.)
M	Load over Height	2,537 mm (8ft. 4 in.)
N	Rear Axle Center to Bin Rear	1,449 mm (4ft. 9in.)
O	Mid Axle Center to Rear Axle Center	1,600 mm (5ft. 2in.)
P	Mid Axle Center to Front Axle Center	3,865 mm (12ft. 8in.)
Q	Front Axle Center to Machine Front	2,357 mm (7ft. 8in.)
R	Front Axle Center to Artic Center	1,361 mm (4ft. 5in)
S	Approach Angle	27°
T	Maximum Bin Tip Angle	70°
U	Maximum Articulation Angle	45°
V	Front Tie Down Height	1,041 mm (3ft. 5in)
W	Machine Lifting Centers	8,845 mm (29ft.)
X	Inner Turning Circle Radius-800/45-30.	3,678 mm (12ft. 1in)
X1	Inner Turning Circle Radius-20.5R2	3,763 mm (12ft. 4in.)
Y	Outer Turning Circle Radius-800/45-30.	7,585 mm (24ft. 1 1 in.)
Y1	Outer Turning Circle Radius-20.5R2	7,499 mm (24ft. 7in.)

Gradeability/Rimpull

1. Determine tractive resistance by finding intersection of vehicle mass line and grade line. NOTE: 2% typical rolling resistance is already assumed in chart and grade line.
2. From this intersection, move straight right across charts until line intersects rimpull curve.
3. Read down from this point to determine maximum speed attained at that tractive resistance.

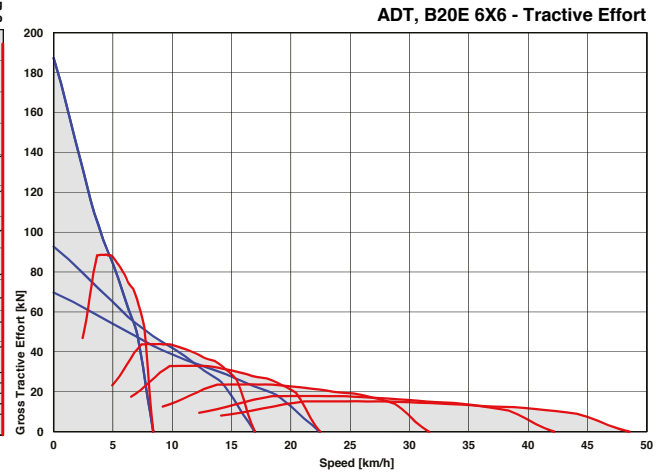
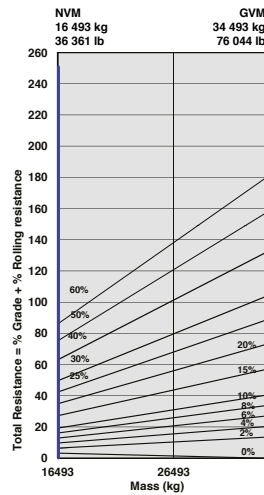

Retardation

1. Determine retardation force required by finding intersection of vehicle mass line.
2. From this intersection, move straight right across charts until line intersects the curve. NOTE: 2% typical rolling resistance is already assumed in chart.
3. Read down from this point to determine maximum speed.

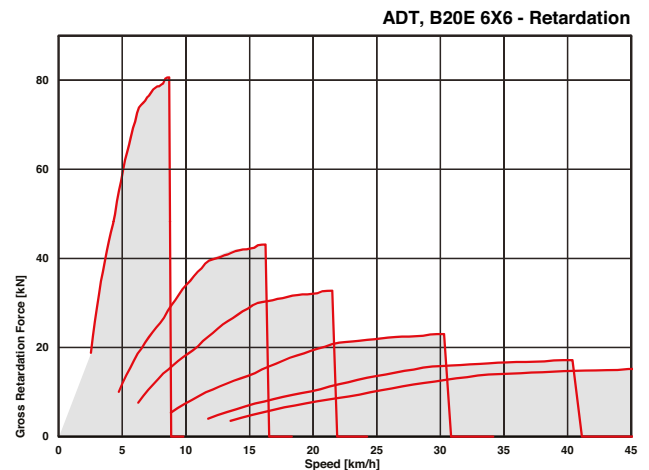
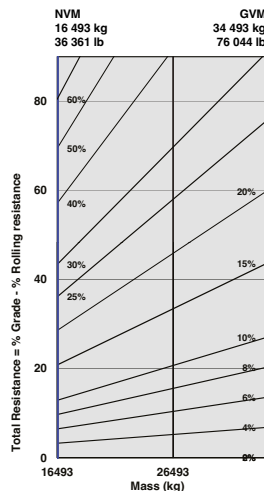

This curve is for a non-retarder transmission

ENGINE

- Jacobs Engine Brake®
- Dual element air cleaner with dust ejector valve
- Precleaner with automatic dust scavenging
- Water separator
- Serpentine drive belt with automatic tensioner
- Provision for fast fill

COOLING

- Crankshaft mounted electronically controlled viscous fan drive
- Fan guard

PNEUMATIC SYSTEM

- Engine-mounted compressor
- Air drier with heater
- Integral unloader valve

ELECTRICAL SYSTEM

- Battery disconnect
- Drive lights
- Air horn
- Reverse alarm
- ▲ White noise reverse alarm
- Rotating beacon
- Rear flashing lights
- Pitch roll sensor
- LED reverse lights
- ▲ LED artic reverse lights
- ▲ Halogen artic reverse lights

STEERING SYSTEM

- Bi-directional ground-driven secondary steering pump

CAB

- ROPS/FOPS certification
- Tilt cab
- Gas strut-supported door
- I-Tip programmable dump-body tip settings
- HVAC climate control system
- AM/FM radio/CD player
- Rear window guard
- Wiper/washer with intermittent control
- Tilt and telescoping steering wheel
- Centre-mount air-suspension seat
- Halogen work lights
- ▲ LED work lights
- ▲ Rotating beacon: seat belt installation
- ▲ Remote engine and machine isolation
- Remote battery jump start
- Retractable 3 point seat belt
- Heated seat
- Foldaway trainer seat with retractable seat belt

CAB

- 12-volt power outlet
- Cab utility bin (removable)
- Cup holder
- Cooled/heated lunch box
- Electric adjustable and heated mirrors
- Deluxe 10" color LCD:
 - Speedometer / Fuel gauge /
 - Transmission oil temperature gauge /
 - Engine coolant temperature gauge /
 - LED function/warning indicators and audible alarm /
 - Transmission gear selection /
 - Tachometer / Battery voltage / Hour meter /
 - Odometer / Fuel consumption / Tip counter /
 - Trip timer / Trip distance / Metric/English units /
 - Service codes/diagnostics.
- Backlit sealed switch module functions with:
 - Wiper control / Lights / Heated mirrors /
 - Retarding aggressiveness / Transfer case differential lock /
 - Transmission gear hold /
 - Dump-body tip limit / Automatic dump-body tip settings /
 - Airconditioner/Heater controls /
 - Preselected Speed Control.

DUMP BODY

- Dump-body mechanical lock - partially up
- ▲ Body liner
- ▲ Tailgate
- ▲ Body heater
- ▲ Less dump body and cylinders

OTHER

- Automation Traction Control (ATC)
- Wet disc brakes
- 800/45 R 30.5 Low Ground Pressure tires
- ▲ 20.5 R 25 Radial Earthmover tires
- Remote grease banks
- Automatic greasing
- Onboard weighing
- ▲ Load lights: stacks
- Reverse camera
- Hand rails
- Cab peak
- ▲ High pressure hydraulic filter
- ▲ Fuel heater
- Belly cover
- Cross member cover
- ▲ Remote transmission filters
- Fleetm@tic® Classic Package for 5 years
- ▲ Window smash button
- Electronic hood opening

The compilation of standard and optional equipment may vary by market region. Please check with your local distributor.

All dimensions are shown in millimeters, unless otherwise stated between brackets.
Under our policy of continuous improvement, we reserve the right to change technical data and design without prior notice. Photographs featured in this brochure may include optional equipment.

BELL INTERNATIONAL: Tel: +27 (0)35-907 9431

E-mail: marketing@bellequipment.com

Web: www.bellequipment.com

 Tel: +61 (0)8-9355-2442

 Tel: +33 (0)5-55-89-23-56

 Tel: +49 (0)6631 / 91-13-0

 Tel: +7-495-287-80-02

 Tel: +27 (0)11-928-9700

 Tel: (704) 655-2802

 Tel: +44 (0)1283-712862